



VIDEO COPY PROCESSOR

MODEL
P66E

OPERATION MANUAL

THIS OPERATION MANUAL IS IMPORTANT
TO YOU.
PLEASE READ IT BEFORE USING YOUR
VIDEO COPY PROCESSOR.



VIDEO COPY PROCESSOR

1 CONTENTS

1	CONTENTS	1
2	PRECAUTIONS	2-4
3	FEATURES AND FUNCTION	
	Front Panel	5
	Rear Panel	6
4	INSTALLATION OF PAPER	7-8
5	EXAMPLE OF CONNECTION/SETTING OF SWITCHES	9-10
6	PRINTING	
	Printing Procedure	11
	Use of Remote Controller	12
7	ADJUSTMENT OF PRINT PICTURE	
	Adjustment of Brightness/Contrast	13-14
8	ERROR DISPLAY	15-16
9	MODE SWITCH FUNCTIONS (MODE1 & 2) ...	17-21
10	SETTING OF FUNCTION MODE	22-28
11	STATUS AND MODES	29
12	USE OF CLEANING PAPER	30
13	MAINTENANCE	31
14	SPECIFICATIONS	32

2 PRECAUTIONS

In the interest of safety, please observe the following precautions:

POWER REQUIREMENT

This Video Copy Processor is designed for opera-

tion on 220-240V, 50Hz, AC. Never connect to any outlet or power supply having a different voltage or frequency.

WARNING: THIS APPARATUS MUST BE EARTHED.

PROTECTIVE MEASURES

IF ABNORMALITIES ARISE,..

Use of the unit during emission of smoke or abnormal sounds (without adopting countermeasures) is dangerous. In such a case, unplug the power cord from the source outlet immediately, and request maintenance services from the sales dealer.

NEVER INSERT ANY OBJECT INTO THE UNIT

Foreign objects of any kind inserted into this unit constitute a safety hazard and can cause extensive damage.

DO NOT PLACE ANYTHING ON THE VIDEO COPY PROCESSOR

Heavy objects placed on the Video Copy Processor can cause damage or obstruct proper ventilation.

PROTECT THE POWER CORD

Damage to the power cord may cause fire or shock hazard. When unplugging, hold by the plug only and remove carefully.

Never put a heavy thing on the power cord. The cord may be damaged causing a fire or electric shock.

DO NOT PLACE WATER CONTAINERS ON THE UNIT

Do not place flower vases, and other water-holding containers on the device. If, for some reason, water seeps to the inside of the unit, unplug the power cord from the source outlet, and contact the sales dealer. If used without corrective measures, the unit

may be damaged.

DO NOT REMOVE THE CABINET

To remove the cabinet parts is dangerous, besides, it may cause damage to the unit. Contact your sales dealer to request maintenance. Before removing the jammed paper, unplug the power cord.

P

T

S

F

I

I

I

TEMPERATURE RANGE

The unit is placed in a cool and dry place.

MOVING PRECAUTION

If the unit is moved quickly from a cooler to a warmer one, condensation may be formed, printing quality may be affected.

TEMPERATURE RANGE

The operating temperature range is 5°C - 35°C.

VENTILATION SLIT

Do not place any material into the paper tray.

The lever located on the right side of the unit. If it is left at the contact with the rubber roller, it may cause uneven printing.

INSTALLATION LOCATIONS

MAINTAIN GOOD VENTILATION

Ventilation slots and holes are provided on the sides of this unit.

Place the unit on a hard and level surface and locate at least 10 cm from walls to ensure proper ventilation.

UNSUITABLE LOCATIONS

Avoid shaky places or hot-springs areas where hydrogen sulfide and acidic ions are likely to be generated.

PLACES WITH HIGH HUMIDITY AND DUST

Do not place the unit in locations with high humidity and or dust. They can cause extensive damage.

For more information, please contact your sales dealer.

EXTREMELY HOT

Do not place the unit in a bright, or near heating source, or in a place with high temperatures, or in a place where it can become a fire hazard.

prime surface

SET THE UNIT ON A FLAT PLACE

Do not use the unit in the state inclined $\pm 20^\circ$ in vertical or horizontal direction, or in an unstable place. It will disturb paper feeding or ventilation, or affects the set.

FOR LONG OPERATING LIFE

UNSUITABLE MATERIALS FOR THE VIDEO COPY PROCESSOR

Many plastic components are used in the back-side. Coat flaking and deformation are likely to occur if the unit is wiped with chemical dusters, benzene, thinner or any other solvent, if rubber or PVC items are left in contact with the unit for extended duration, or if the unit is sprayed with insecticide.

CARE OF THE CABINET

Unplug and clean with a soft cloth slightly moistened with a mild soap and water solution. Allow to dry completely before operating.

Never use petroleum base solutions or abrasive cleaners.

HEAD ABRASION

The thermal head, like the video head, wears out. When it is abraded, it becomes hard to print out fine details of the picture. In such a case, it is necessary to replace the thermal head. Consult with the sales dealer for replacing the head.

WHEN A DEFECT IS FOUND

When you detect smoke or smell from the unit, disconnect immediately the power cord plug from a wall socket and ask the agent for repair. Dangerous if the unit is operated in that state.

CONNECTION DEVICES

Read thoroughly "Operating Precautions" of the instruction booklets for the devices connected with the Video Copy Processor.

Do not disconnect the power cord during printing.

CAUTION ON RELOCATING

When transporting this unit, make sure it is not likely to be subjected to impacts. They can be a prime cause for damage. Further, make sure to disconnect the power cord from the power outlet, and the cables from the connected devices.

UNPLUG THE POWER CORD DURING A LONG ABSENCE

Turn off the MAIN power switch and unplug the power cord during a long absence.

THERMAL PAPER

- Thermal paper K65HM (High-density synthetic paper for high quality printing) is available.
- One roll of K65HM permits printing about 260 pictures in "paper saving mode".
- When the remaining length of the paper is about 40cm, a color belt appears at the paper end. Prepare for replacement of the paper. If the remaining paper length is less than 40cm, printing becomes uneven due to the uneven paper core surface.
- When the Printed paper is touched by wet hand, the print may be discolored.
- When the paper runs out during printing, the printing operation stops and "EP" is displayed by the indicator on the front panel. Install new paper at this time.
- Store the printed paper in a place with low humidity free from a direct sunlight.
- If the paper absorbs non-volatile organic solvents (alcohol, ester, ketone, etc.), the print may be discolored. Particularly, if the paper is in contact with soft vinyl chloride such as a transparent tape, it quickens discoloration.
- Do not use paper other than the specified one.
- Immediately after the paper is replaced, 2~3 images may be printed with a blank part due to hand's dust or oil.
- Avoid a direct sunlight or a place near a heater, and store the paper in a place with 30°C or lower temperature and 20-80% RH.
- When the paper is rapidly transferred from a cool place to a hot place, a vapor or a dew is generated on the paper surface causing paper jam or degraded printing quality. Leave the paper in a room to familiarize with the temperature before using it.
- A finger print or dust on the paper surface may degrade the printing quality.

Note:

Mitsubishi brand thermal paper is specially treated with an anti-static coating against thermal head damage caused by static electric discharge. The use of non-treated paper may cause premature head failure in your product.

SAFETY TECHNICAL CHECKS

Terms: The safety test has to be done, according to the specified terms of § 11 chp. 1 MedGV mentioned in the certificate acc. § 22 chp. 1, § 22 chp. 2 or acc. to the type approval § 5 MedGV or according to the recommendation of the medical set manufacturer.

- Items:**
- a) Visual check
Housing, cables, operator controls, readout device (displays, LED etc.), labels, accessories, instruction manual.
 - b) Function test
Performance check acc. instruction manual, also unity and applicability of set and accessory test.
 - c) Electrical check
Safety electrical test of the configuration in accordance with VDE 0751.

"In the interest of safety, avoid the handling of liquids beside the set."

RESPONSIBILITY OF THE MANUFACTURER

The manufacturer, assembler, installer or importer considers himself responsible for the effects on safety, reliability and performance of the EQUIPMENT only if:

- assembly operations, extensions, re-adjustments, modifications or repairs are carried out by persons authorized by him, and
- the electrical installation of the relevant room complies with the IEC requirements
- the EQUIPMENT is used in accordance with the instructions for use.

TECHNICAL DESCRIPTION

The supplier will make available on request such circuit diagrams, component part lists, descriptions, calibration instructions or other information which will assist the USER's appropriately qualified technical personnel to repair those parts of the EQUIPMENT which are classified by the manufacturer as repairable.

3 FEATURES AND FUNCTION

Front Panel

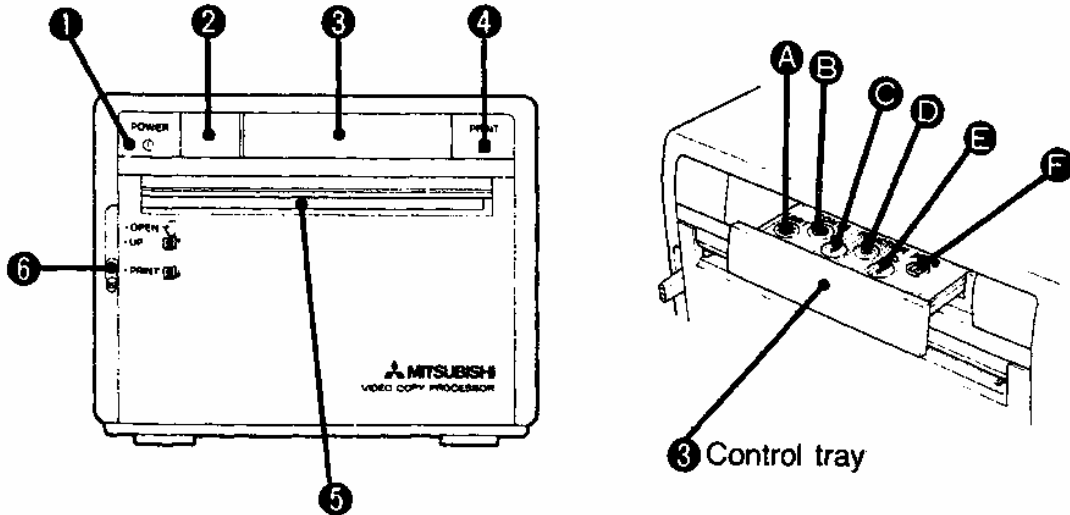

	Name	Function	Reference page
①	POWER switch	Turns on/off the power.	11
②	Indicator	Displays standby, functions and error messages.	22-29
③	Control tray		
	Ⓐ Brightness button	Adjusts brightness.	
	Ⓑ Contrast button	Adjusts contrast.	
	Ⓒ Function value change button	Changes each function value Select paper feed mode	11-14
	Ⓓ Function button	Selects functions.	
	Ⓔ Function value change/ Copy button	Changes each function value./ Press this button in standby state for additional copies of the previous print-out.	
	Ⓕ Print-Sub button	Press this button to memorize and print.	11-17
④	Print button	Press this button to memorize and print the picture displayed at that instant. Press this button to paper feeding or printing in "paper saving mode".	11-17 12
⑤	Print exit/Cutter	Printed paper will come out through this slot.	11
⑥	Lever	Front panel open-close/Thermal head up- down	7-11

Rear Panel

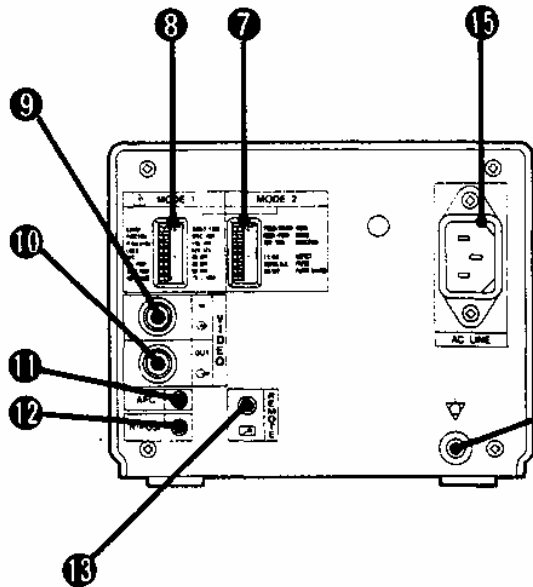

*** TYPE CF EQUIPMENT**
 Class I or II EQUIPMENT or EQUIPMENT with an INTERNAL ELECTRICAL POWER SOURCE, providing a high degree of protection against electric shock particularly regarding allowable LEAKAGE CURRENTS, and having an F-TYPE ISOLATED (FLOATING) APPLIED PART. TYPE CF EQUIPMENT is primarily intended for DIRECT CARDIAC APPLICATION.

14 Potential equalization terminal
 This is used to equalize the potential of the equipment connected to this unit. In medical rooms, when CF-type equipment* are connected, it is necessary to equalize the potential of both units. For details, refer to the installation instruction of the equipment to be connected.

	Name	Function	Reference Page
7	MODE 2 switch	Selects a special function.	19-21
8	MODE 1 switch		17-18
9	VIDEO IN connector (BNC type)	Video signal input	9-10
10	VIDEO OUT connector (BNC type)	Video signal output (Monitor output)	9
11	AFC control	Adjust AFC	—
12	Horizontal position control	Adjust the horizontal position of a picture.	—
13	Remote control terminal	Terminal to connect the remote controller	12
14	Potential equalization terminal	Makes the connected equipment potential equal.	10
15	Power terminal	Connect the power cord to this terminal.	9-10

4 INSTALLATION OF PAPER

Paper (High-density paper K65HM)

■ Moisture, fingerprint or dust on the paper surface may cause a noise at printing or deterioration in print quality. Set the paper in the following procedure to prevent adhesion of fingerprint or dust on the paper surface.

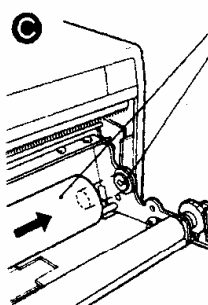

- Set the paper roll first on the left side paper holder.
- Set the paper roll on the right side paper holder.

1 Open the door.

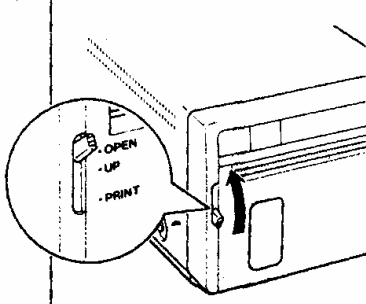

- Switch the lever located on the left side to the "OPEN" position.
- The door opens.

3 Close the door. Pull out the paper end.

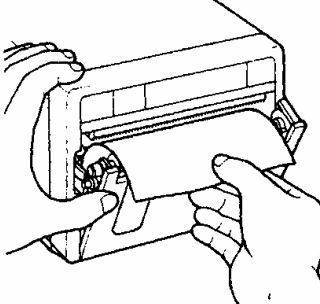

- Pull out the touched paper end (about 15-20 cm), and close the door.

2 Load the paper roll.

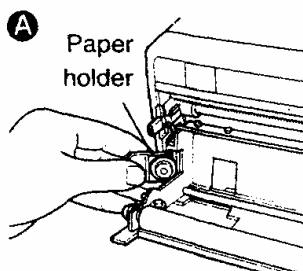

- Enlarge the paper holder located on the left side leftward.

4 Cut the paper end.

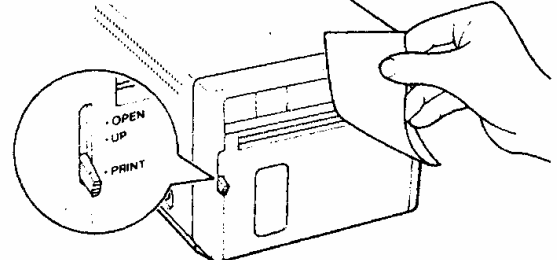

- Switch the lever to the "PRINT" position.
- Cut the paper end with the cutter just like tearing off the paper.

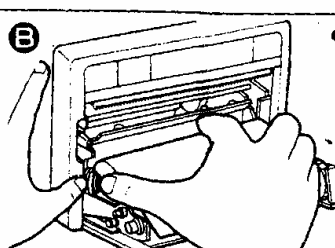

- Hold the paper holder with your fingers, and load the paper roll.

5 Flip up the lever.

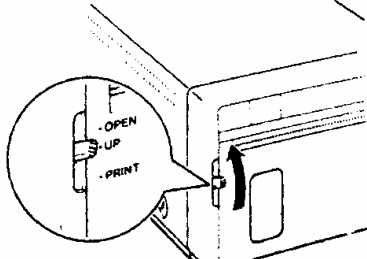

- Switch the lever to the "UP" position if printing is not to begin right away.

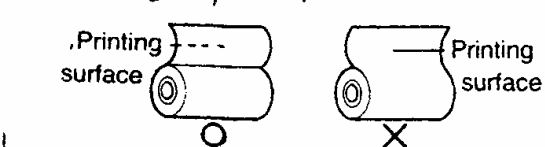

Note: The printing surface is the outside. Set the paper roll as shown in the illustration marked "O".

■ When setting the paper, observe the following precautions to prevent paper jam.

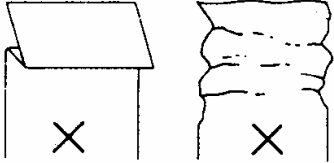
<p>Do not use defective paper.</p>	<p>■ Do not use the bent or wrinkled paper.</p>
	

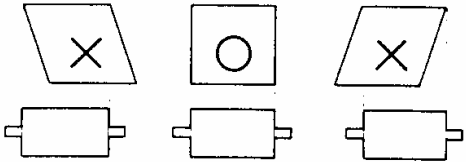
<p>Adjust the paper position correctly.</p>	<p>■ When the paper is fed out skewed from the print exit, adjust the paper position so that it is fed out straight.</p>
	

<p style="text-align: center;">CAUTION</p>	
<ul style="list-style-type: none">● Keep the high-density paper away from fingerprint, dust or moisture when storing it.● Do not touch the rubber roller. Do not stain or damage the roller surface.● Do not touch your hand to the thermal head (located behind the cutter). The thermal head is heated to high temperature.● Do not touch the cutter blade.● Do not switch the lever to the “PRINT” position without loading paper.	

5

EXAMPLE OF CONNECTION/SETTING OF SWITCHES

- Connectable to various composite video signal equipments such as medical equipment.

a Connection

Video signal equipment

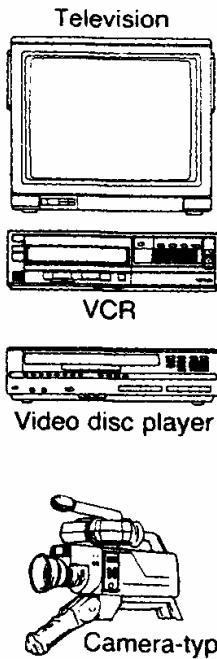

- ① Turn off the power switches of the Video copy processor and the connected equipment.
- ② Connect the VIDEO input terminal of the Video copy processor to the video output terminal of the connected equipment.

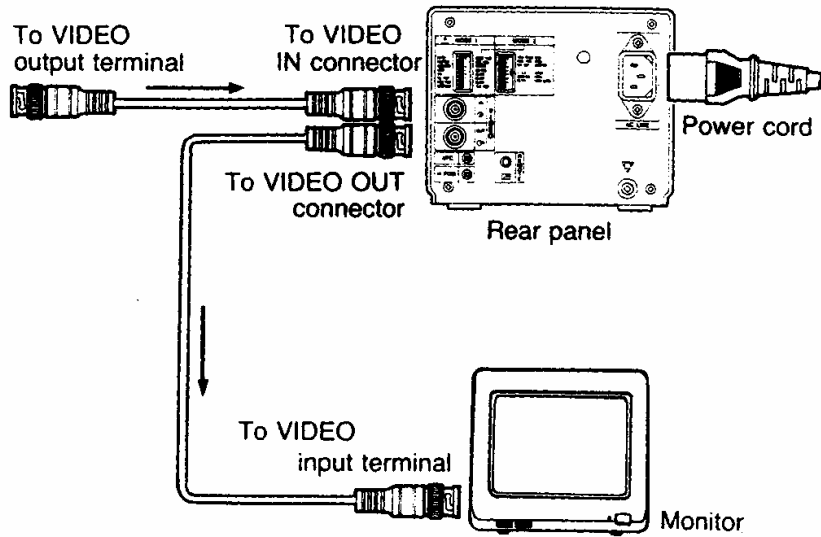

b Setting of Switches

- Set the switches of MODE 1 as follows. (This is standard setting.)

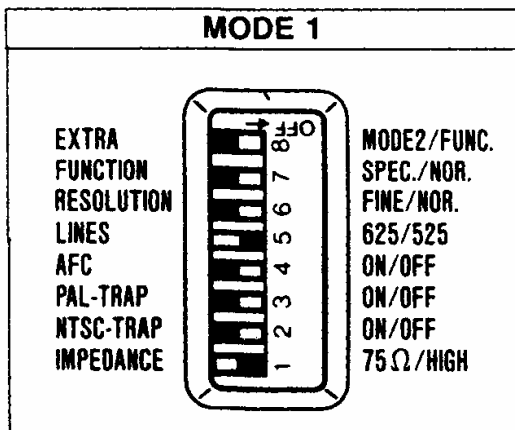

	Switch	Setting
No. 8	EXTRA	FUNC.
No. 7	FUNCTION	NOR.
No. 6	RESOLUTION	NOR.
No. 5	LINES	625
No. 4	AFC	OFF
No. 3	PAL-TRAP	OFF
No. 2	NTSC-TRAP	ON
No. 1	IMPEDANCE	75Ω

Select γ -curve "4" for video equipment. Refer to the γ -curveset mode on page 27.

■ For the function of MODE switch, refer to the “9. MODE SWITCH FUNCTIONS” 17-21.

a Connection

- ① Turn off the power switches of the Video copy processor and the connected equipment.
- ② Connect the VIDEO IN terminal of the video copy processor with the VIDEO OUT terminal of the connected equipment.

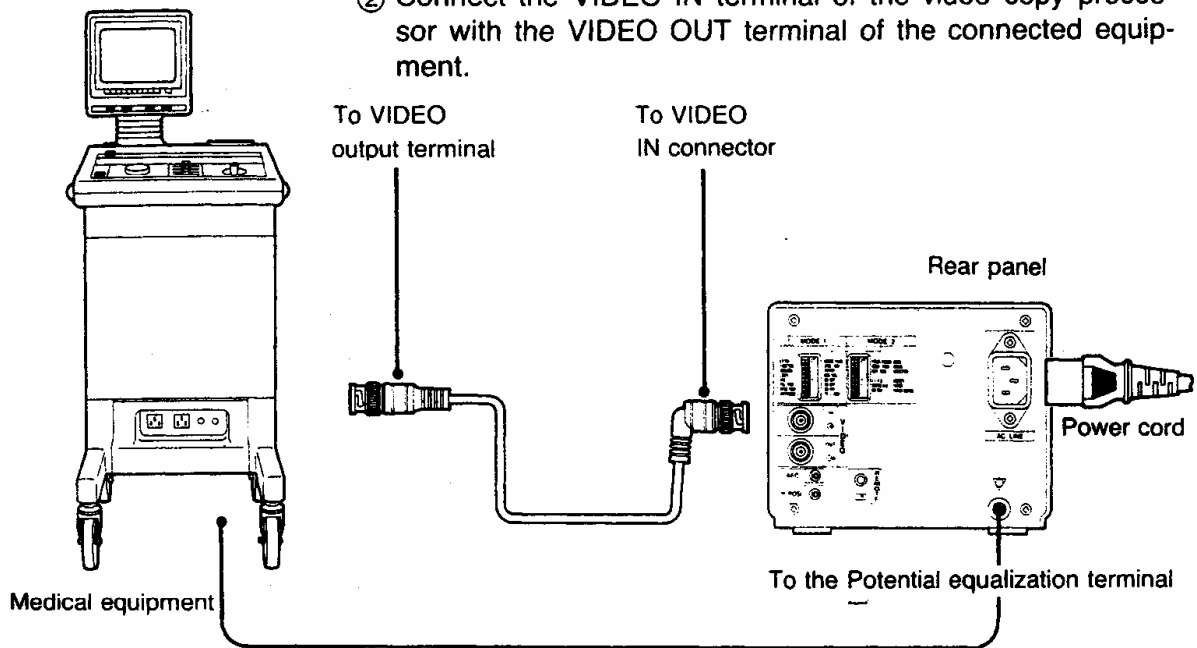

When connecting with a medical equipment, use the equipotential grounding cable for safety. (Refer to the page 6.)

b Setting of Switches

- Set the switches of MODE 1 as follows. (This is standard setting.)

MODE 1		Switch	Setting
EXTRA FUNCTION RESOLUTION LINES AFC PAL-TRAP NTSC-TRAP IMPEDANCE		MODE2/FUNC.	
		SPEC./NOR.	
		FINE/NOR.	
		625/525	
		ON/OFF	
		ON/OFF	
		ON/OFF	
		75Ω/HIGH	
No. 8	EXTRA	FUNC.	
No. 7	FUNCTION	NOR.	
No. 6	RESOLUTION	NOR.	
No. 5	LINES	625	
No. 4	AFC	OFF	
No. 3	PAL-TRAP	OFF	
No. 2	NTSC-TRAP	OFF	
No. 1	IMPEDANCE	75Ω	

Select γ -curve “1”-“3” for ultrasonic diagnosis equipment. Especially “3” is suggested. Refer to the γ -curveset mode on page 27.

6 PRINTING

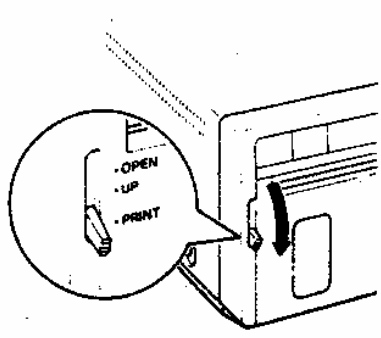
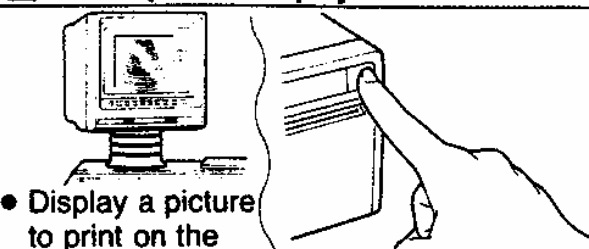
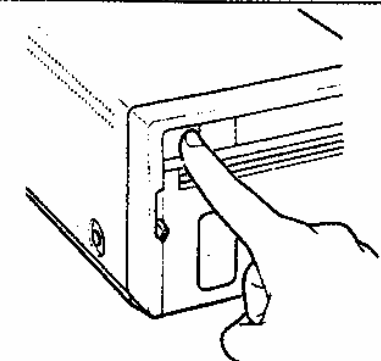
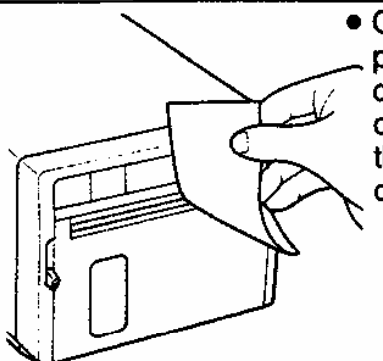
<p>1 Set the lever to the "PRINT" position.</p>  <ul style="list-style-type: none"> • The lever located on the left side to the "PRINT" position. 	<p>3 Print a picture displayed on the screen.</p>  <ul style="list-style-type: none"> • Display a picture to print on the monitor screen, and push the "PRINT" or "PRT-S" button. ■ When printing is over, it warns by a buzzer tone, if selected.
<p>2 Turn on the power.</p>  <ul style="list-style-type: none"> • Push the "POWER" switch to turn on the power. 	<p>4 Cut the printed paper.</p>  <ul style="list-style-type: none"> • Cut the printed paper with the cutter by tearing off the paper in the upper right direction.

- When printing ends, switch the lever to the "UP" position.
- When you set the "RESOLUTION" switch to "NOR." then push the "PRINT" button for normal print, push the "PRT-S" button for fine (side) print.

Copy Printing

- By pressing the "▲/COPY" button in the control tray, you can copy the same picture as many times as you desire until the "PRINT" button is pushed again.

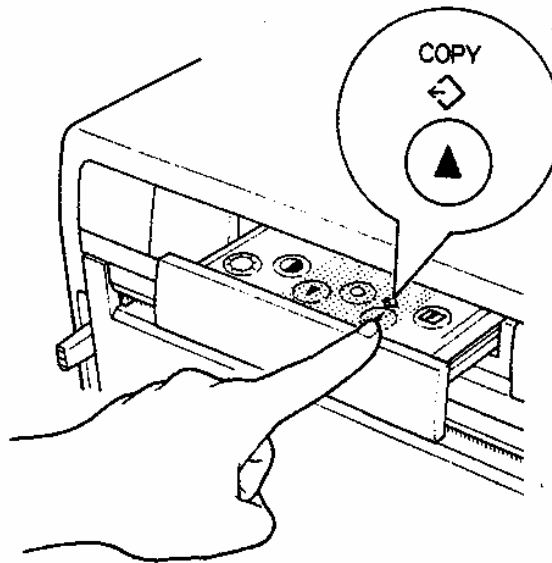

Use of Remote Controller

- Connect the wired remote controller to the remote control terminal on the rear panel.
- Press the remote control button to print pictures. This performs the same function as the print button.

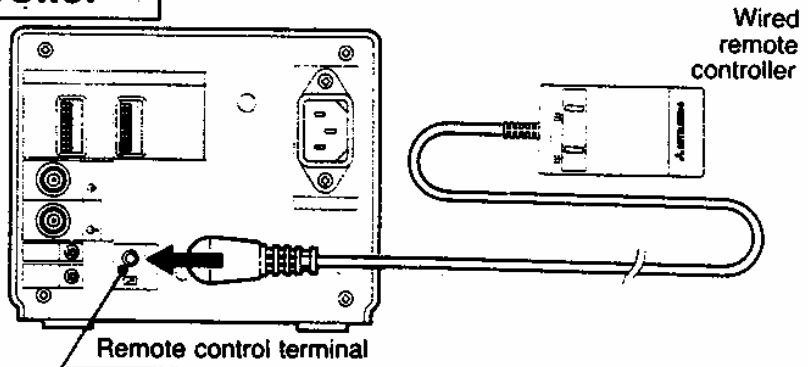

Precautions on Printing

- If printing is continued with a very black picture, the printer may become overheated, causing failure of normal printing. ("EH" is indicated, and the print density becomes thin.)
In this case, wait for a while until the unit is cooled down.
- Avoid pulling out or holding the recording paper during printing or copying. It can cause paper jam. Do not touch the paper until printing or copying ends.

Paper saving mode

When the paper saving mode is selected to on, "PRINT" button function will be changed as follows (See pages 21 and 26).

- A) When "PRINT" button is pressed within 1 second, printing will be started.
- B) When "PRINT" button is pressed for longer than 1 second, paper will be fed by about 0.6 inch.

Caution: In this mode, print feeding distance is shorter than normal condition.

Before cutting the print, press the "PRINT" button to feed paper up to appropriate cutting position.

7 ADJUSTMENT OF PRINT PICTURE

Adjustment of Brightness/Contrast

You can adjust brightness and contrast of print while observing the monitor screen.

1. Open the control tray

- Push the "CONTROL TRAY" panel.

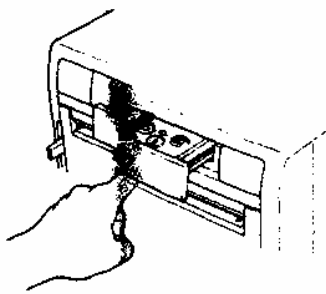

■ The control tray comes out.

2. Select the mode to adjust brightness.

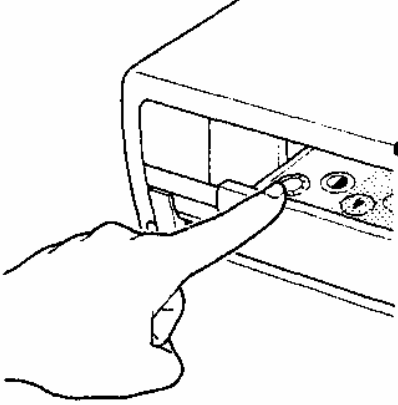

- Press the bright button "☀" to adjust brightness.

3. Select the mode to adjust contrast.

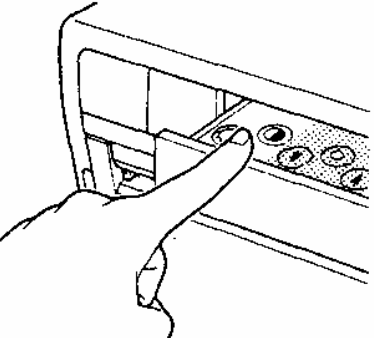

- Press the contrast button "☾" to adjust contrast.

■ The following buttons are provided in the control tray.

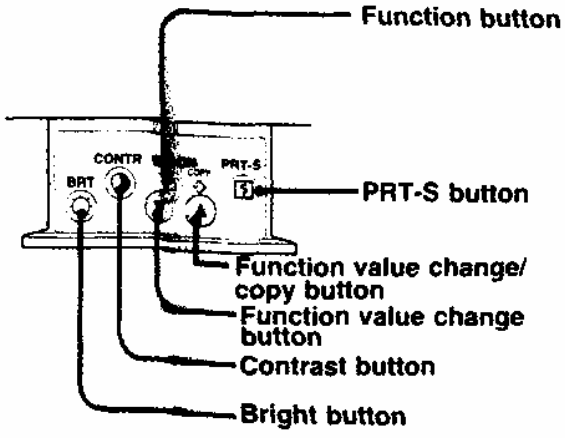

- Function button
- PRT-S button
- Function value change/copy button
- Function value change button
- Contrast button
- Bright button

■ To adjust pictures, use the bright button "☀", the contrast button "☾" and the function value change button "▲/▼".

■ The selected mode is displayed on the left side indicator as shown below.

Mode	Indicator
Bright	b
Contrast	c

3 Change the set value.

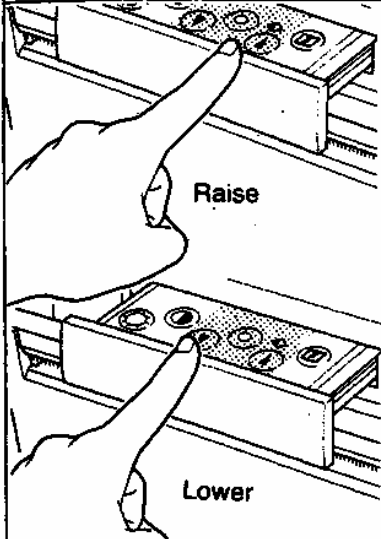

- Press the function value change button "▲" to raise the value.
- Press the function value change button "▼" to lower the value.

- A value is stored by pressing either the print "□", bright "○", contrast "●" or function "○" buttons is pressed.

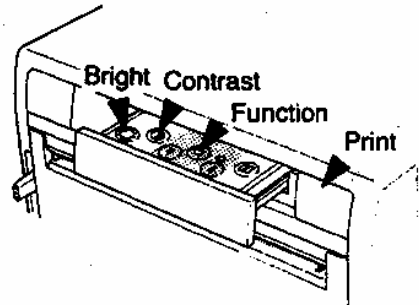

- The set value is displayed on the right side of the indicator.

Example: Brightness adjustment



Minus (-) value is indicated by "•".



Set value.

- Setting range is -9 to +9.

- A stored value will not be lost even if the power is turned off or the "FUNCTION" switch of MODE 1 is operated.

8 ERROR DISPLAY

When an error in operation occurs it is warned by an audible alarm and a visible error display in the indicator.

Cause/Error display	Symptom/Remedy
<p>① Dew</p> 	<p>[Symptom]</p> <ul style="list-style-type: none"> • When dew is condensed in the set, it is warned by a alarm tone. • When dew is condensed in the set with the lever at the "PRINT" position, it is warned by a continuous alarm tone. • Printing is impossible. <p>[Remedy]</p> <p>Take out the recording paper contaminated with dew and ventilate the set. When the set is restored and ready for printing, "00" is displayed in the indicator.</p> <p>Use of dew contaminated paper cause a defect.</p> <p>Replace the paper with a brand-new roll.</p>
<p>② No paper</p> 	<p>[Symptom]</p> <ul style="list-style-type: none"> • When the paper runs out or the door opens during printing, printing becomes impossible and or alarm tone is given. • When the lever is at the "PRINT" position at this time, an alarm tone is repeated. <p>[Remedy]</p> <p>Install brand-new paper according to "4. INSTALLATION OF PAPER" on page 7.</p>
<p>③ Overheat</p> 	<p>[Symptom]</p> <ul style="list-style-type: none"> • When the print button is pressed with the head overheated, an alarm tone is given and "EH" is displayed for 2 seconds in the indicator and then, printing occurs. <p>In this case, the print density is thin.</p> <p>[Remedy]</p> <p>Wait until the head is cooled down.</p>

Cause/Error display	Symptom/Remedy
<p data-bbox="177 465 440 501">④ Head left down</p> 	<p data-bbox="462 465 608 501">[Symptom]</p> <ul data-bbox="462 501 1398 734" style="list-style-type: none"> • When the print button is not pressed for over 30 minutes with the lever set to the “PRINT” position, an alarm tone is given once. • “EU” is displayed in the indicator, and the buttons, except for the print button become invalid. • If the set is left in this state, an alarm tone is given every 30 minutes and the paper is automatically fed about 0.5mm, to prevent roller damage. <p data-bbox="462 745 596 781">[Remedy]</p> <p data-bbox="462 781 1289 817">Press the print button, or set the lever to the “UP” position.</p>

Cause/Error display	Symptom/Remedy
<p data-bbox="177 960 440 1028">⑤ Lever operation error</p> 	<p data-bbox="462 960 608 996">[Symptom]</p> <ul data-bbox="462 996 1422 1167" style="list-style-type: none"> • Printing is impossible simply by pressing the PRINT button without setting the lever to the “PRINT” position. When the lever is moved during printing, printing is interrupted. • “EL” is displayed for one second in the indicator, and the set goes into the standby state. <p data-bbox="462 1245 596 1281">[Remedy]</p> <p data-bbox="462 1281 1315 1317">Re-set the lever to the “PRINT” position, and repeat printing.</p>

Cause/Error display	Symptom/Remedy
<p data-bbox="177 1456 440 1523">⑥ Button input error</p> 	<ul data-bbox="462 1456 1398 1727" style="list-style-type: none"> • An alarm tone is given once in the following cases. “Eb” is displayed for one second in the indicator, and this button operation is nullified. <ul data-bbox="462 1559 1362 1727" style="list-style-type: none"> ① The function value change button “▲” or “▼” is pressed exceeding the value during adjustment of density, brightness, contrast or copy number. ② Aspect ratio is set to 1:1 in the aspect set mode with the RESOLUTION (FINE/NOR) of MODE 2 set to “FINE”.

9

MODE SWITCH FUNCTIONS (MODE1)

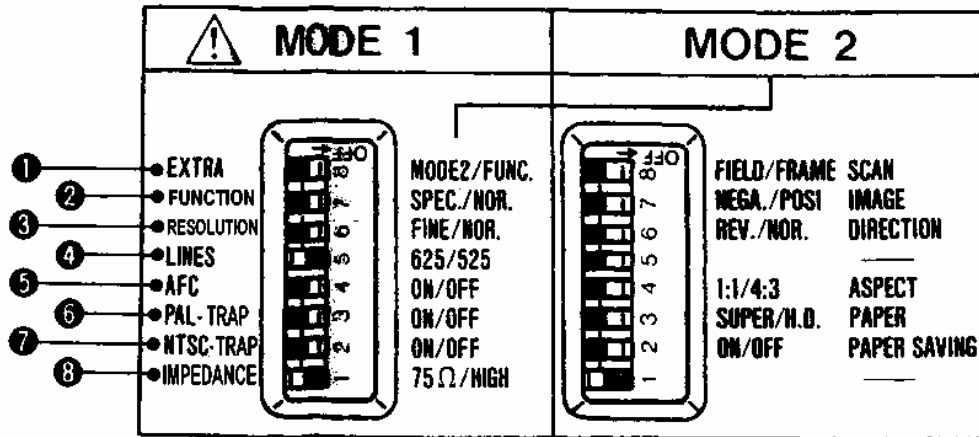

MODE 1 (DIP switch)	Function
① EXTRA MODE2/FUNC.	Set this switch to select the special function mode (Function 1-3). Use in combination with ② FUNCTION switches MODE2: Each switch function of MODE2 becomes valid. Setting of Function 1 and 3 becomes valid. FUNC.: Setting of Function 2 and 3 becomes valid. Each function of MODE2 becomes invalid. (See page 22.)
② FUNCTION SPEC./NOR.	Set this switch to select the special function mode (Function 1-3). Use in combination with ① EXTRA switch. Setting function is different at SPEC. and NOR. positions. (See page 22.)
③ RESOLUTION FINE/NOR.	Set this switch to change the "PRINT" and "PRT-S" button function. NOR: "PRINT" button function is normal print. "PRT-S" button function is fine (side) print. FINE: "PRINT" button function is fine (side) print. "PRT-S" button function is normal print. See next page.

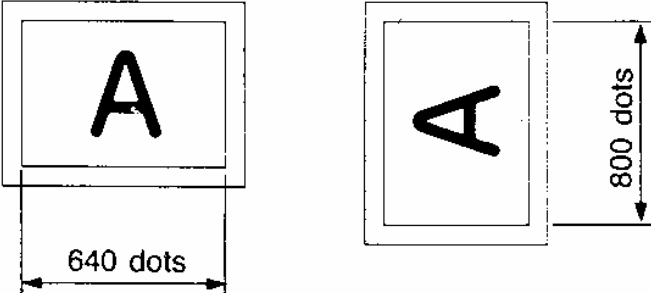
MODE 1 (DIP switch)	Function
③	<p>Normal Print: The number of effective horizontal picture elements is 640 on the monitor screen and printed picture.</p> <p>Fine Print (side): The number of effective horizontal picture elements is 800 on the monitor screen and printed picture.</p> <p>A picture is printed 90° turned from the display.</p> <div style="text-align: center;">  </div> <p style="text-align: center;">Normal Print Fine (side) Print</p>
④ LINES 625/525	<p>Set to "625" when connecting equipment which uses PAL (B/G/H/I) signal.</p> <p>Set to "525" when connecting an equipment which uses NTSC signal.</p>
⑤ AFC ON/OFF	<p>Usually set to "OFF".</p> <p>Set to "ON" when connecting a VCR, etc.</p> <p>Picture quality will be improved.</p>
⑥ PAL-TRAP ON/OFF	<p>When this is set to "ON", the 4.43MHz PAL trap circuit functions.</p> <p>At "OFF", the trap is invalid.</p>
⑦ NTSC-TRAP ON/OFF	<p>When this is set to "ON", the 3.58MHz NTSC trap circuit functions.</p> <p>At "OFF", the trap is invalid.</p>
⑧ IMPEDANCE 75Ω/HIGH	<p>Usually set to "75Ω".</p> <p>Set to "HIGH" when making branch connection of a monitor or other units to VIDEO IN connector.</p>

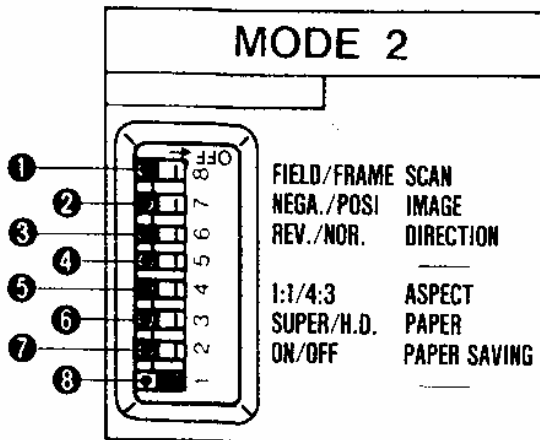

9

MODE SWITCH FUNCTIONS (MODE 2)

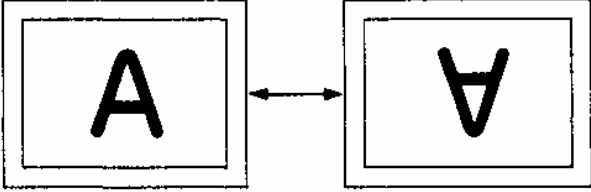

- When the EXTRA switch of MODE 1 is set to "MODE 2", the switches of MODE 2 become valid. Setting of FUNCTION 2 and FUNCTION 3 becomes invalid in this case. (See page 22.)

MODE 2 (DIP switch)	Function
① SCAN FIELD/FRAME	<p>FRAME: Usually set to "FRAME" position. FIELD: Set to "FIELD" position to print an image with rapid motion. Vertical resolution of a printed picture is 1/2 of that at FRAME.</p> <p>■ Usually two field pictures are synthesized for a monitor picture, and one frame picture is displayed.</p>
② IMAGE NEGA./POSI.	<p>NEGA: A picture is printed reverse to the display (negative). POSI: A picture is printed as displayed (positive).</p> <div style="text-align: center;"> </div>

MODE 2 (DIP switch)	Function
③ DIRECTION REV./NOR.	<p>NOR: A picture is printed in the same direction as the display. REV: A picture is printed reverse to the display (180° turned).</p> <p>This switch is invalid in Fine print. (See page 17, ③ RESOLUTION switch.)</p> <div style="text-align: center;">  </div> <div style="display: flex; justify-content: space-around; width: 100%;"> NOR REV </div>
④ _____	Not used
⑤ ASPECT 1:1/4:3	<p>4:3: Aspect ratio of printed picture is 4:3. (This is normal print.) 1:1: Aspect ratio of printed picture is 1:1.</p> <div style="text-align: center;">  </div> <div style="display: flex; justify-content: space-around; width: 100%;"> 4:3 print 1:1 printed </div> <p>■ At the fine print, the aspect ratio is 4:3 irrespectively of setting of ⑤ ASPECT switch. (See page 17, ③ RESOLUTION switch.)</p>

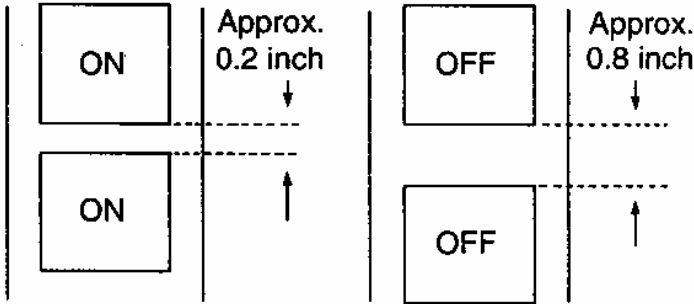
MODE 2 (DIP switch)	Function						
⑥ PAPER SUPER/H.D.	Set this switch as follows to suit the recording paper used. <table border="1" data-bbox="568 510 1326 656" style="margin: 10px auto;"> <thead> <tr> <th>Position</th> <th>Recording paper</th> </tr> </thead> <tbody> <tr> <td>SUPER</td> <td>K61S</td> </tr> <tr> <td>HD</td> <td>K65HM</td> </tr> </tbody> </table>	Position	Recording paper	SUPER	K61S	HD	K65HM
Position	Recording paper						
SUPER	K61S						
HD	K65HM						
⑦ PAPER SAVING ON/OFF	Set this switch to select the margin size. ON: Printed with narrow margin. OFF: Printed with normal margin. <div style="text-align: center; margin: 20px 0;">  </div>						
⑧ _____	Not used						

10 SETTING OF FUNCTION MODE

Adjustable items are divided into three groups of FUNCTION1-3. Select a desired function by setting EXTRA and FUNCTION switches of MODE 1.

※ Unrelated

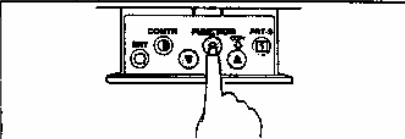
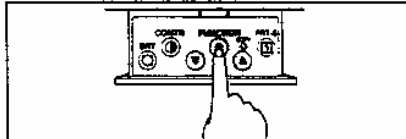
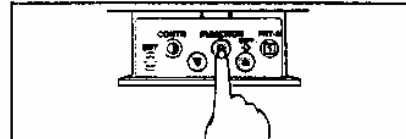
FUNCTION 1	FUNCTION 2	FUNCTION 3
Setting of MODE 1 Switches EXTRA <input type="checkbox"/> MODE2/FUNC. FUNCTION <input type="checkbox"/> SPEC/NOR.	Setting of MODE 1 Switches EXTRA <input type="checkbox"/> MODE2/FUNC. FUNCTION <input type="checkbox"/> SPEC/NOR.	Setting of MODE 1 Switches EXTRA <input checked="" type="checkbox"/> MODE2/FUNC. FUNCTION <input type="checkbox"/> SPEC/NOR.
		

■ Each time the function button is pressed, the mode is switched as shown below.

Density adjust mode 80 ↓ Saturation monitor set mode 50 ↓ Standby 00	Density adjust mode 80 ↓ Saturation monitor set mode 50 ↓ Scan set mode Fr ↓ Image set mode IP ↓ Print direction set mode On ↓ Aspect ratio set mode R4 ↓ Paper set mode PX ↓ Paper saving mode on ↓ Standby 00	γ-curve set mode r3 ↓ Edge enhance mode e2 ↓ Dither select mode 00 ↓ Buzzer set mode 81 ↓ Copy number set mode C1 ↓ Cumulative picture number print mode n0 ↓ Standby 00
--	---	--

FUNCTION 1

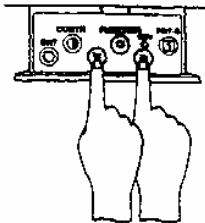

- Set a numeric value by pressing ▲ or ▼ of the function value set button.
- Adjustable items of FUNCTION 1 are as follows.





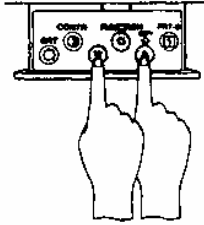

Indicator/Adjustable item	Adjustment contents						
<p data-bbox="188 725 293 808"> </p> <p data-bbox="300 725 507 757">Density adjust</p> <p data-bbox="284 869 459 900">Adjust range</p> <p data-bbox="293 913 453 1025"> </p> <p data-bbox="197 1070 453 1137">"●" indicates "-" (minus).</p>	<p data-bbox="529 725 1362 860"> ■ Mode to adjust the printed picture density. Density is thin with a smaller set number, and thick with a larger number. Setting range is -9 to +9. </p>						
<p data-bbox="188 1180 293 1263"> </p> <p data-bbox="300 1180 507 1270">Saturation monitor set mode</p> <p data-bbox="293 1368 453 1451"> </p>	<p data-bbox="529 1180 1331 1279">This function inverses the signal polarity (white/black) of a picture exceeding the adjustment range of brightness and contrast.</p> <div data-bbox="612 1323 1378 1659"> </div> <table border="1" data-bbox="544 1727 986 1868"> <thead> <tr> <th>Selection</th> <th>Indicator on right side</th> </tr> </thead> <tbody> <tr> <td>ON</td> <td>1</td> </tr> <tr> <td>OFF</td> <td>0</td> </tr> </tbody> </table> <p data-bbox="1008 1718 1426 1874">● When brightness or contrast is adjusted so that an inverted part is eliminated, a picture can be obtained with tone of normal graduation.</p>	Selection	Indicator on right side	ON	1	OFF	0
Selection	Indicator on right side						
ON	1						
OFF	0						

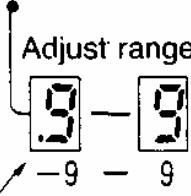
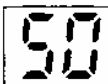
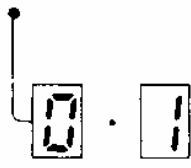
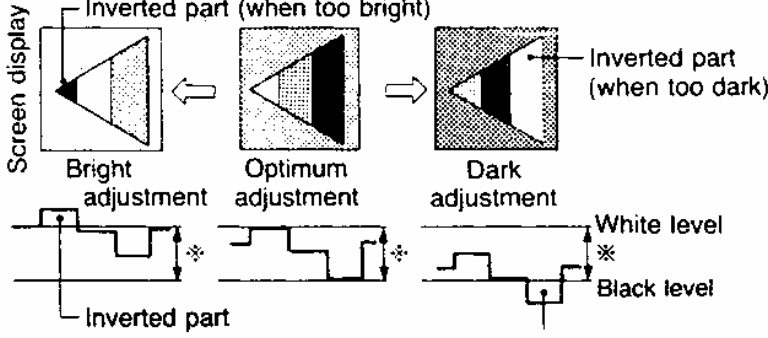
FUNCTION 2

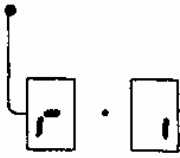

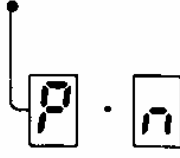
- Set a numeric value by pressing ▲ or ▼ of the function value set button.
- Adjustable items of FUNCTION 2 are as follows.

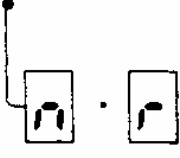
Indicator/Adjustable item	Adjustment contents						
 <p>Density adjust</p>  <p>Adjust range</p> <p>“•” indicates “-” (minus).</p>	<ul style="list-style-type: none"> ■ Mode to adjust the printed picture density. <p>Density is thin with a smaller set number, and thick with a larger number.</p> <p>Setting range is -9 to +9.</p>						
 <p>Saturation monitor set mode</p> 	<ul style="list-style-type: none"> ■ Mode to adjust brightness and contrast. <p>※ This function inverses the signal polarity (white/black) of a picture exceeding the adjustment range of brightness and contrast.</p>  <table border="1" data-bbox="534 1720 975 1861"> <thead> <tr> <th>Selection</th> <th>Indicator on right side</th> </tr> </thead> <tbody> <tr> <td>ON</td> <td>1</td> </tr> <tr> <td>OFF</td> <td>0</td> </tr> </tbody> </table> <ul style="list-style-type: none"> ● When brightness or contrast is adjusted so that an inverted part is eliminated, a picture can be obtained with tone of normal graduation. 	Selection	Indicator on right side	ON	1	OFF	0
Selection	Indicator on right side						
ON	1						
OFF	0						

 <p>Scan set mode</p> 	<p>■ Mode to select frame or field for printing.</p> <p><i>r</i> : A frame picture is printed.</p> <p><i>f</i> : A field picture is printed.</p>
 <p>Image set mode</p> 	<p>■ Mode to print in negative (reverse to the display).</p> <p><i>p</i> : A picture is printed as the display.</p> <p><i>n</i> : A picture is printed reverse to the display.</p>
 <p>Print direction set mode</p> 	<p>■ Mode to select the printing direction.</p> <p><i>n</i> : A picture is printed in the same direction as the display.</p> <p><i>r</i> : A picture is printed in the reverse direction to the display.</p> <div style="display: flex; align-items: center; justify-content: center;">   </div> <p>■ This function is invalid in fine (side) print.</p>

A4

Aspect ration
set mode

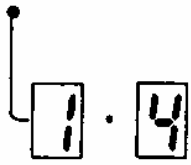

■ Mode to select the aspect ratio of printed picture.

1: The vertical-to-horizontal ratio of printed picture is 1:1.

4: The vertical-to-horizontal ratio of printed picture is 4:3.

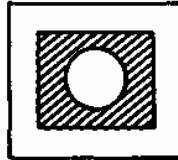

4:3 print

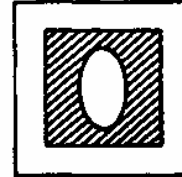

1:1 print

PH

Paper set
mode

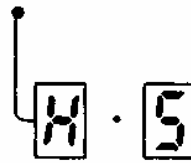

■ Set this switch as follows to meet the recording paper to be used.

Selection	Recording paper
S	K61S
H	K65HM

an

Paper saving
mode

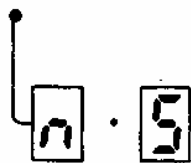

■ Mode to select the margin size.

S: Printed with narrow margin.

n: Printed with normal margin.

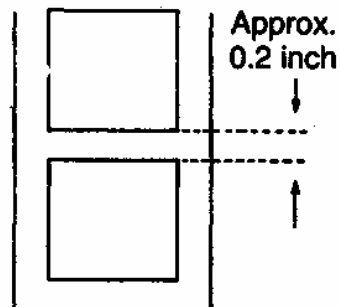

Narrow Margin

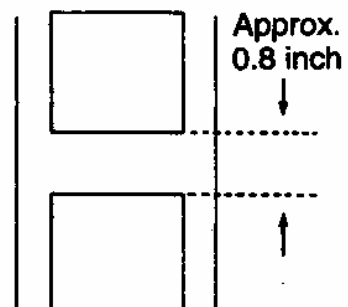





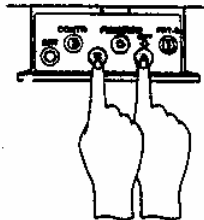

Normal Margin

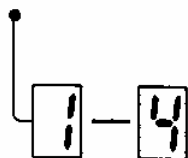
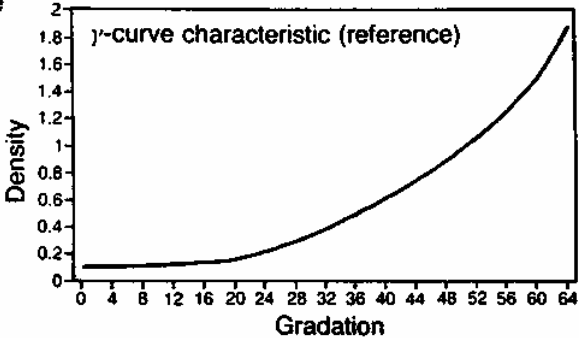
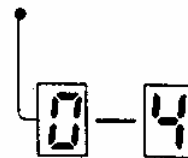
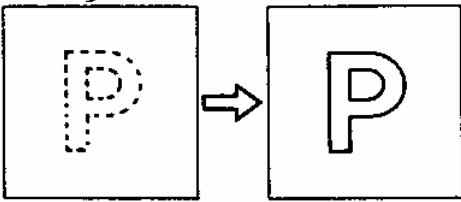
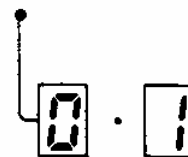
FUNCTION 3

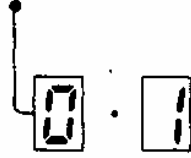

- Set a numeric value by pressing ▲ or ▼ of the function value set button.
- Adjustable items of FUNCTION 3 are as follows.

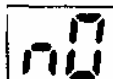
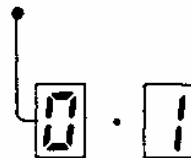
Indicator/Adjustment item	Adjustment contents						
<p>73 γ-curve set mode</p> 	<ul style="list-style-type: none"> ■ Mode to select the γ-curve (density-graduation characteristic) to provide an optimum print to meet the connected unit. Select from four types to meet a printing picture. Select γ-curve "4" for video equipment. Select γ-curve "1"-"3" for ultrasonic diagnosis equipment. Especially "3" is suggested. 						
<p>22 Edge enhance mode</p> 	<ul style="list-style-type: none"> ■ Mode to enhance the printed picture contour.  <p>Setting range is 0-4. As the set value is larger, the enhancement effect is grates.</p>						
<p>01 Dither select mode</p> 	<ul style="list-style-type: none"> ■ Mode to select ON/OFF of the dither function. Graduation is improved four times apparently. <table border="1" data-bbox="542 1765 979 1908"> <thead> <tr> <th>Selection</th> <th>Indicator on right side</th> </tr> </thead> <tbody> <tr> <td>ON</td> <td>1</td> </tr> <tr> <td>OFF</td> <td>0</td> </tr> </tbody> </table>	Selection	Indicator on right side	ON	1	OFF	0
Selection	Indicator on right side						
ON	1						
OFF	0						



Indicator/Adjustable item	Adjustment contents						
 <p>Buzzer set mode</p> 	<ul style="list-style-type: none"> Mode to select whether or not to sound the buzzer at depression of buttons or at the end of printing. 1: Buzzer sounds. 0: Buzzer does not sound. (Sounds at occurrence of error.) 						
 <p>Copy number set mode</p> 	<ul style="list-style-type: none"> Mode to set the number of copies. Setting range is 1-9. When the print button "⊞" is pressed, a picture is printed by the number set by this function. When the copy button "◊" is pressed, the same picture as that printed last is copied by the number set by this function. 						
 <p>Cumulative picture number print mode</p> 	<ul style="list-style-type: none"> By this setting, a cumulative picture number can be printed on the print. The specified number is printed at "ON" and not printed at "OFF". <table border="1" data-bbox="534 1545 973 1691"> <thead> <tr> <th>Selection</th> <th>Indicator on right side</th> </tr> </thead> <tbody> <tr> <td>ON</td> <td>1</td> </tr> <tr> <td>OFF</td> <td>0</td> </tr> </tbody> </table>  <p>ON: 123 (Example of printing number) OFF: Not printed</p>	Selection	Indicator on right side	ON	1	OFF	0
Selection	Indicator on right side						
ON	1						
OFF	0						

11 STATUS AND MODES

Set state/Mode	LED display		Contents of right side LED display	Video output
	Left	Point and right		
Power off			Power off	Through
Standby	0	0	Resolution: NOR.	Through
	o	o	Resolution: FINE	
Print state	-	-	Print state	Through
Density set mode (Density)	d	.9-9	Print density index	Through
Saturation monitor set mode (Saturation)	S	0.1	Out/In (OFF/ON)	Monitor
Scan set mode	F	r, 1	Frame/Field	Through
Image set mode (Image)	1	P, n	Posi/Nega	Through
Print direction set mode	0	r, n	Reverse/Normal	Through
Aspect ratio set mode (Aspect)	R	4, 1	4:3/1:1	Through
Paper set mode (Paper)	P	H, S	HD paper/Super paper	Through
γ -curve set mode (γ -curve)	r	1-4	γ -curve No.	Through
Edge enhance mode (Edge)	e	0-4	Edge enhance index	Through
Dither select mode (Gradation)	G	0, 1	Out/In (OFF/ON)	Monitor
Buzzer set mode (Buzzer)	B	0, 1	Out/In (OFF/ON)	Through
Copy number set mode (Copy)	C	1-9	Copy number	Through
Cumulative picture number print mode (Number)	n	0, 1	Out/In (OFF/ON)	Through
Brightness adjust mode (Bright)	b	.9-9	Brightness index	Monitor
Contrast adjust mode (Contrast)	c	.9-9	Contrast index	Monitor
Error detect state	E	H, d P, U b, L	Overheat/Dew No paper/Head down Button input error/Lever operation error	Through
Paper feed mode	H	C	Head Cleaning	Through
Paper saving mode	o	n, S	Margin setting	Through

12 USE OF CLEANING PAPER

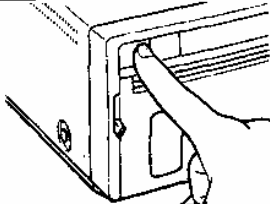
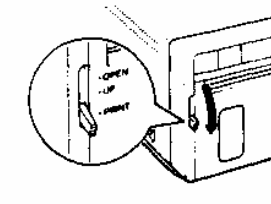
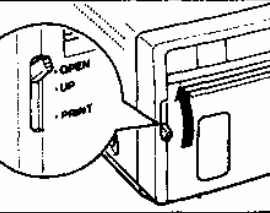
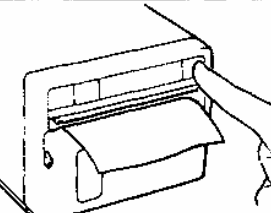
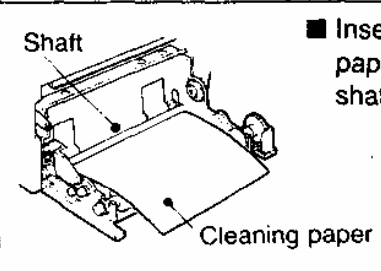
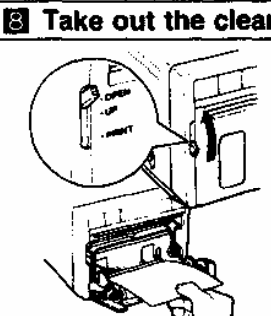
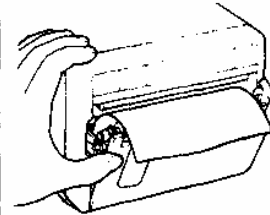
When the thermal head is dirty with dust and perspiration, etc., white spots or stripes may appear on the print. In this case, clean the thermal head in the following procedure by using the supplied cleaning paper.

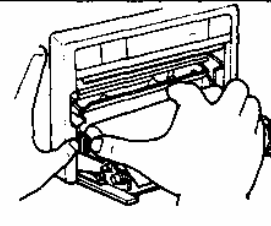
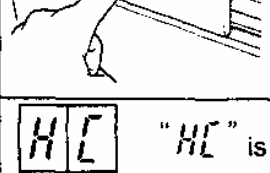
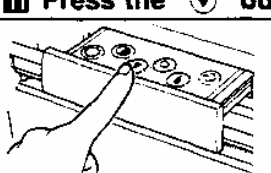
<p>1 Turn on the power.</p>  <ul style="list-style-type: none"> ■ Push the "POWER" switch to turn on the power. 	<p>6 Set the lever to the "PRINT" position.</p>  <ul style="list-style-type: none"> ■ The lever located on the left side to the "PRINT" position.
<p>2 Open the door.</p>  <ul style="list-style-type: none"> ■ Switch the left side lever to the "OPEN" position. ● The door opens. 	<p>7 Press the "PRINT" button.</p>  <ul style="list-style-type: none"> ■ Press the "PRINT" button only once. ● The cleaning paper will come out about 2 inch.
<p>3 Insert the cleaning paper.</p>  <ul style="list-style-type: none"> ■ Insert the cleaning paper end under the shaft in the set. 	<p>8 Take out the cleaning paper.</p>  <ul style="list-style-type: none"> ■ Open the door. ■ Take out the cleaning paper. ■ Do not pull out the cleaning paper while the door is closed.
<p>4 Close the door.</p>  <ul style="list-style-type: none"> ■ Close the door without taking out the cleaning paper. 	<p>9 Repeat the steps 3-8 by 1 or 2 times, and print 2~3 sheets to verify the cleaning effect.</p>
<p>5 Press the "▼" button.</p>  <ul style="list-style-type: none"> ■ Press the "▼" button to select "PAPER FEED" mode. 	<p>10 Install the paper roll.</p>  <ul style="list-style-type: none"> ■ Install the paper. See "4. installation of paper."
<p>11 Press the "▼" button.</p>  <p>HC "HC" is displayed in the indicator.</p>	<p>11 Press the "▼" button.</p>  <ul style="list-style-type: none"> ■ Press the "▼" button to exit the "PAPER FEED" mode.

CAUTION:

- Using the cleaning paper too many times may affect the thermal head. Once after printing 10 roles of paper is a standard period of using the cleaning paper.
- If the symptom of the dirty head is not corrected even after cleaning, your set needs repairing. Contact your dealer.
- Do not pull out the sheet and the cleaning paper while the door is closed.
- Never use other cleaning papers. It may cause damage to the thermal head.

13 MAINTENANCE

Turn off the power for maintenance.

Maintenance of Main Unit

Wipe off stains of the front panel with a soft cloth.
When the panel is heavily stained, wipe off with the cloth moistened with neutral cleanser diluted by water and finish with a dry cloth.

Maintenance of Rubber Roller

When the rubber roller is dirty with dust, etc., a blank spot may appear on the print.
In this case, eliminate the dust on to the rubber roller with a blower or a brush.

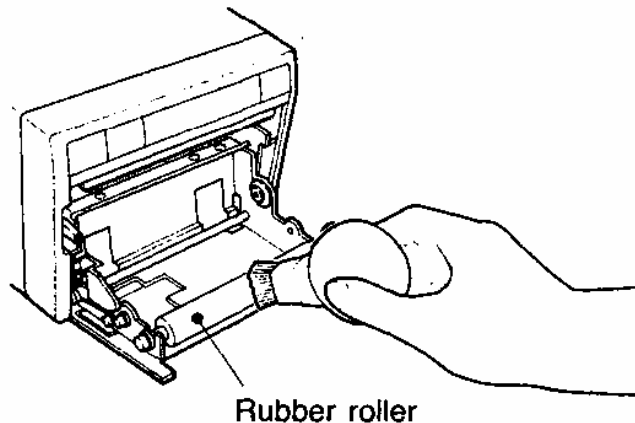

Cleaning of Thermal Head

When the thermal head is dirty with dust, etc., white spots or stripes may appear on the print.
In this case, clean the thermal head according to "12. USE OF CLEANING PAPER".

14 SPECIFICATIONS

Type:	Video Copy Processor
Model:	P66E
Power supply:	220–240V AC 50Hz
Power consumption:	1.0A
Connection terminals:	Video input terminal (BNC contact plug) Video output terminal (BNC contact plug)
Resolution:	Horizontal 640 dots × Vertical 600 lines (Standard) (PAL) Horizontal 800 dots × Vertical 600 lines (Side feed) (PAL)
Gradation:	256 gradations
Printing speed:	5.8 sec (Standard) (PAL)
Print size:	100 × 75mm (Standard)
Operating conditions:	Temperature 5-40°C Humidity 35-80% RH (No dewing)
Outside dimensions:	154(W) × 125(H) × 314(D) mm
Weight:	3.9 kg
Standard accessories:	BNC/BNC connection cable (2m) 1 piece AC power cord 1 piece Thermal paper K65HM 1 roll Wired remote controller 1 set Cleaning paper 1 sheet Easy operation label 1 sheet
Optional accessory:	Thermal paper K65HM

CALLING FOR SERVICE

Before requesting service please review this operation manual to correct minor complaints. If you are unable to correct the problem, consult your MITSUBISHI Dealer or MITSUBISHI Service Department.

DO NOT ADJUST ANY CONTROLS NOT DESCRIBED IN THIS OPERATION MANUAL.

DO NOT REMOVE THE PROTECTIVE ENCLOSURE OF THIS UNIT.

APPENDIX

Default settings of MODE1 & MODE2 switch

Function button on Control tray: FUNCTION 2 ... see pg. 22

